

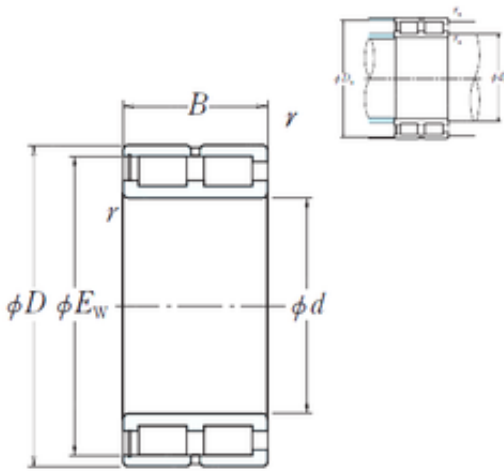

JLB Bearing Technology Co., Ltd

NNCF4844V NSK Double row full complement cylindrical roller bearings

Bearing No. NNCF4844V



NNCF4844V Bearing 2D drawings and 3D CAD models

Size	220x256.9x50 mm
Bore Diameter	220 mm
Outer Diameter	256,9 mm
Width	50 mm
d	220 mm
D	270 mm
Ew	256,9 mm
B	50 mm
C	50 mm
r min.	1,5 mm
Da	257 mm
ra max.	1,5 mm
da	233 mm
Weight	6,4 Kg
Basic dynamic load rating (C)	340 kN