

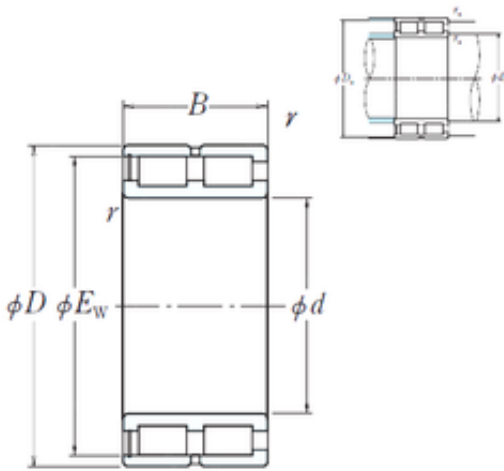

JLB Bearing Technology Co., Ltd

NNCF4860V NSK Double row full complement cylindrical roller bearings

Bearing No. NNCF4860V



NNCF4860V Bearing 2D drawings and 3D CAD models

Size	300x357.2x80 mm
Bore Diameter	300 mm
Outer Diameter	357,2 mm
Width	80 mm
d	300 mm
D	380 mm
Ew	357,2 mm
B	80 mm
C	80 mm
r min.	2,1 mm
Da	361 mm
ra max.	2 mm
da	318 mm
Weight	23 Kg
Basic dynamic load rating (C)	805 kN