

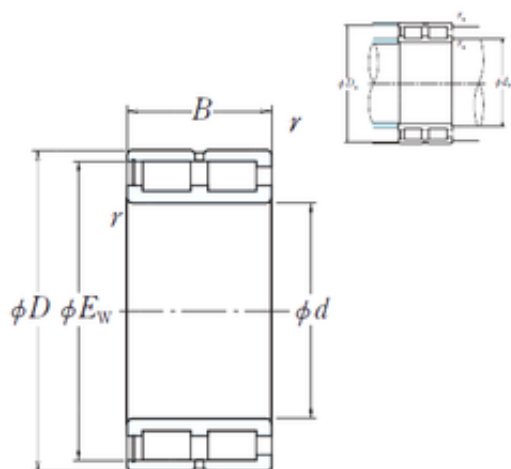

JLB Bearing Technology Co., Ltd

NNCF4928V NSK Double row full complement cylindrical roller bearings

Bearing No. NNCF4928V



NNCF4928V Bearing 2D drawings and 3D CAD models

Size	140x176.2x50 mm
Bore Diameter	140 mm
Outer Diameter	176,2 mm
Width	50 mm
d	140 mm
D	190 mm
Ew	176,2 mm
B	50 mm
C	50 mm
r min.	1,5 mm
Da	178 mm
ra max.	1,5 mm
da	151 mm
Weight	4,2 Kg
Basic dynamic load rating (C)	272 kN