

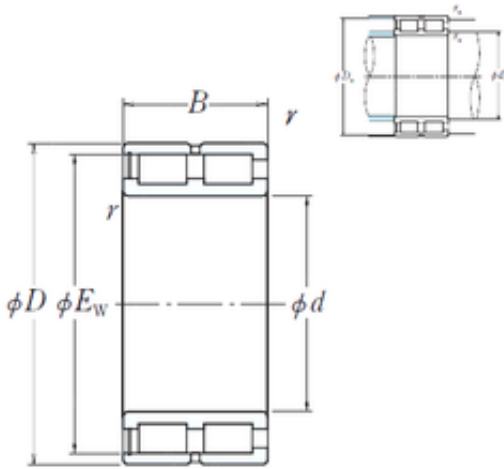

# JLB Bearing Technology Co., Ltd

## NNCF4932V NSK Double row full complement cylindrical roller bearings

Bearing No. NNCF4932V



NNCF4932V Bearing 2D drawings and 3D CAD models

Size	160x204.1x60 mm
Bore Diameter	160 mm
Outer Diameter	204,1 mm
Width	60 mm
d	160 mm
D	220 mm
Ew	204,1 mm
B	60 mm
C	60 mm
r min.	2 mm
Da	206 mm
ra max.	2 mm
da	173 mm
Weight	7 Kg
Basic dynamic load rating (C)	410 kN